

कार्यालय अधीक्षक सह जिला आयुर्वेद अधिकारी, दमोह

स्थापना-1	स्वी.पद	भरे पद
आयु.चिकि.अधि.	38	35
कम्पा.	38	25
दाई	32	25
औष.सेवक	32	23
पी.टी.एस.	32	31
नर्सिंग सिस्टर	1	
स्टाफ नर्स	3	1

स्थापना-1	स्वी. पद	भरे पद
अधी.सह.जि.आ.अधि.	1	1
मुख्य लिपिक	1	1
लेखापाल	1	1
सहायक ग्रेड 2	2	
सहायक ग्रेड 3	2	2
भृत्य	2	1
स्वच्छक	1	1

स्थापना-1	स्वी.पद	भरे पद
होम्योपे.चिकि.अधि.	1	
सहायक होम्यो.चि.अधि.	1	1
कम्पाउंडर	1	1
दाई	1	1
औषधालय सेवक	2	2
पी.टी.एस.	2	1

औषधालय		
जिला आयु.चिकि.	ग्रा.औषधा.	होम्यो.औष.
1	35	2

समस्या

सुझाव

कार्यालय अधीक्षक सह जिला आयुर्वेद अधिकारी, दमोह

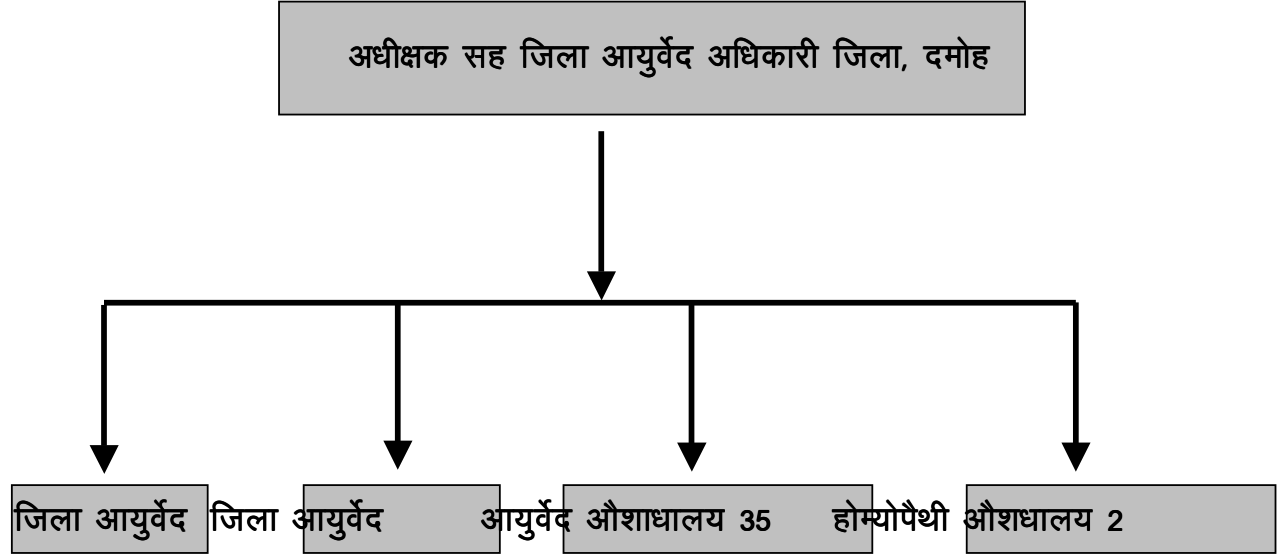

कार्यालय अधीक्षक सह जिला आयुर्वेद अधिकारी, दमोह

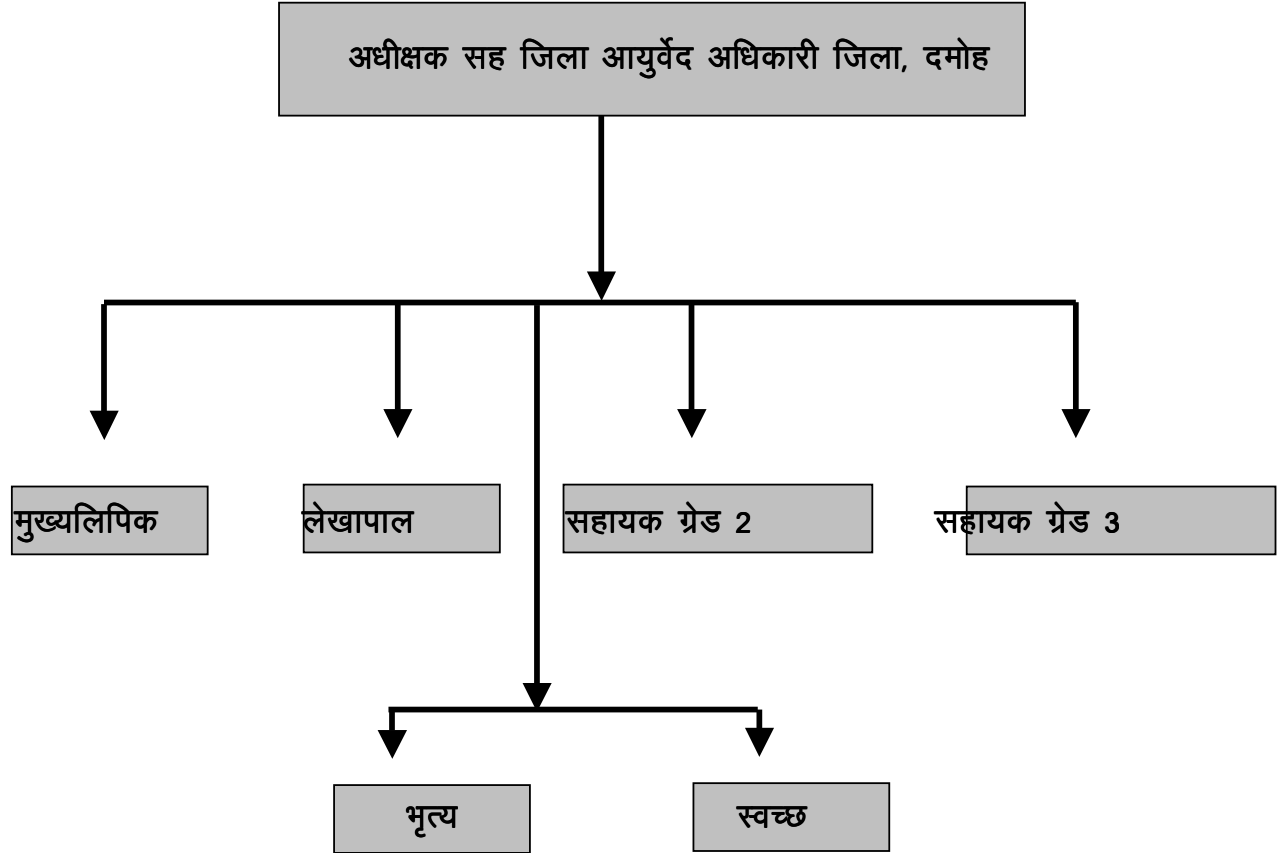

कार्यालय अधीक्षक सह जिला आयुर्वेद अधिकारी, दमोह

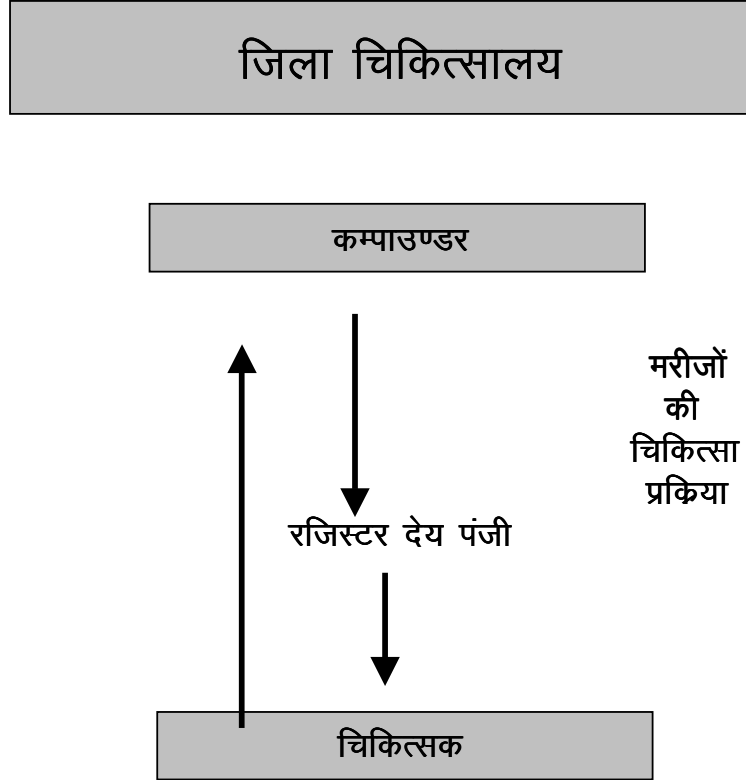

कार्यालय अधीक्षक सह जिला आयुर्वेद अधिकारी, दमोह

औशधालयों का सेटअप

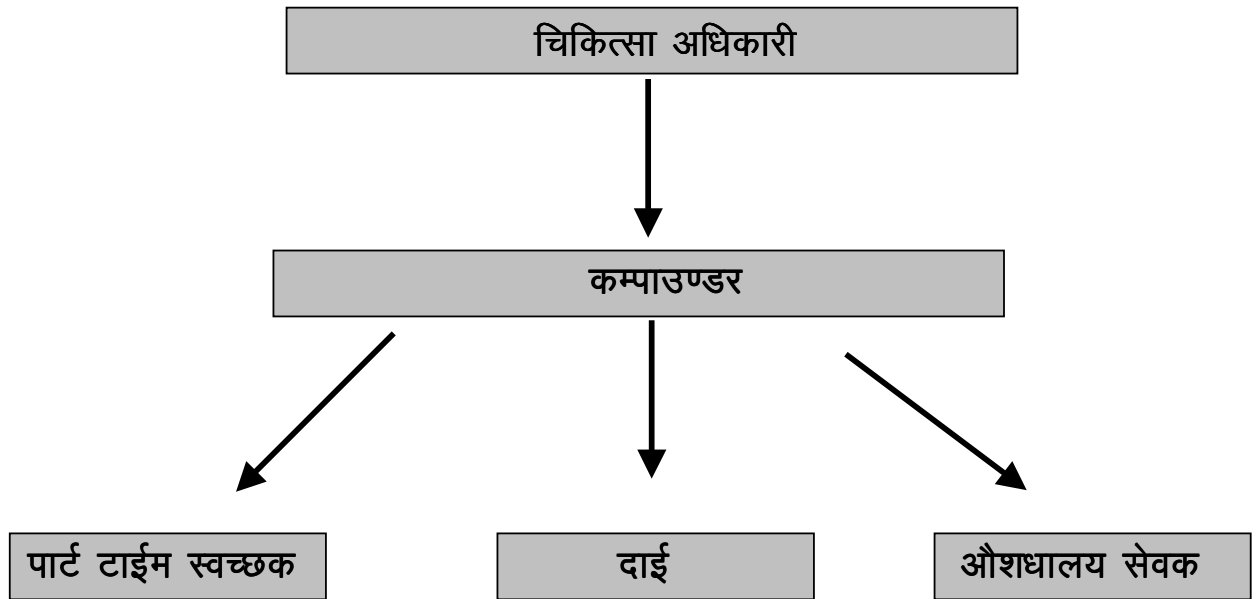

कार्यालय अधीक्षक सह जिला आयुर्वेद अधिकारी, दमोह

क्र0	नाम कर्मचारी	पद नाम	कर्तव्य	वेतन	सुविधायें	पता	फोन नं.
1	2	3	4	5	6	7	8
1	डॉ.पी.पी.शर्मा	अधीक्षक सह जिला आयुर्वेद अधिकारी	प्रशासनिक अधिकारी	15,200.00		एफ-9 पी.डब्ल्यू डी रेस्ट हाउस के पास,दमोह	224377
				3,800.00			
				9,500.00			
				9,120.00			
				37,620.00			
2	श्री अशोक सिंह ठाकुर	मुख्य लिपिक	स्थापना	5,500.00		स्व.प्रेमशंकर वार्ड नं.15,दमोह	227661
				250.00			
				2,750.00			
				2,640.00			
				220.00			
				11,360.00			
3	श्रीमती त्रिवेणी बाई गौतम	लेखापाल	लेखा संबंधी	5,800.00		पॉलीटेकनिक छात्रावास के पास दमोह	223291
				2,900.00			
				2,784.00			
				232.00			
				11,716.00			
4	श्री सीताराम प्रजापति	सहायक ग्रेड 3	स्टोर / सामान्य	3,950.00		नया बाजार नं.5 दमोह	
				1,975.00			
				1,896.00			
				158.00			
				7,979.00			
5	श्री विनोद कुमार कटारहा	भृत्य	सेवक	3,345.00		हजारी की तलैया बजरिया वार्ड नं.4,दमोह	226083
				1,673.00			
				1,606.00			
				134.00			
				30.00			
				6,788.00			
6	श्री नरेश कुमार पाण्डेय	स्वच्छक	सफाई	2,602.00		तीन गुल्ली तिगड्डा दमोह	
				2,602.00			

कार्यालय अधीक्षक सह जिला आयुर्वेद अधिकारी, दमोह
अधीन : आयुर्वेद / होम्यो औषधालयों में कार्यरत स्टाॅफ

क्र०	नाम कर्मचारी	पद नाम	कर्तव्य	वेतन	पता	फोन नं.
1	डॉ.अनिल चौधरी	आयु.चि.अधि.	चिकित्सीय कार्य	30,476.00	पो.ग्राम अभाना	
2	डॉ.आर.के. मिश्रा	आयु.चि.अधि.	चिकित्सीय कार्य	23,309.00	पो.ग्राम बालाकोट	
3	डॉ.अनीस खान	आयु.चि.अधि.	चिकित्सीय कार्य	23,309.00	पो.ग्राम नोहटा	
4	डॉ. पी.के.खरे	आयु.चि.अधि.	चिकित्सीय कार्य	23,309.00	पो.ग्राम किशुनगंज	
5	डॉ. पी.एन.खरे	आयु.चि.अधि.	चिकित्सीय कार्य	26,566.00	पो.ग्राम बम्होरीमाला	
6	श्री संतोष कुमार खरे	आयु.चि.अधि.	चिकित्सीय कार्य	27,188.00	पो.ग्राम पटनामानगढ़	
7	श्री पी.एस.गुप्ता	आयु.चि.अधि.	चिकित्सीय कार्य	21,554.00	पो.ग्राम बनवार	
8	श्री डी.पी.विश्वकर्मा	आयु.चि.अधि.	चिकित्सीय कार्य	26,109.00	चिकित्सालय दमोह	
9	श्री एस.एस.इकबाल	आयु.चि.अधि.	चिकित्सीय कार्य	23,109.00	पो.ग्राम झलौन	
10	श्री हीरालाल जैन	आयु.चि.अधि.	चिकित्सीय कार्य	26,566.00	पो.ग्राम बनगांव	
11	श्री एल.बी.खरे	आयु.चि.अधि.	चिकित्सीय कार्य	26,566.00	पो.ग्राम रजपुरा	
12	श्री आर.के.गांगरा	आयु.चि.अधि.	चिकित्सीय कार्य	28,078.00	चिकित्सालय दमोह	
13	श्री के.के.तिवारी	आयु.चि.अधि.	चिकित्सीय कार्य	29,825.00	पो.ग्राम बांदकपुर	
14	श्री आर.जी.साहू	आयु.चि.अधि.	चिकित्सीय कार्य	29,173.00	पो.ग्राम मोहरई	
15	श्री रविशंकर तिवारी	आयु.चि.अधि.	चिकित्सीय कार्य	23,309.00	पो.ग्राम छेवलादुबे	
16	श्री आर.एस.ताम्रकार	आयु.चि.अधि.	चिकित्सीय कार्य	23,309.00	पो.ग्राम मनका	
17	श्री एम.एल.नेमा	आयु.चि.अधि.	चिकित्सीय कार्य	21,554.00	पो.ग्राम सीतानगर	
18	श्री एम.एम.सेन	आयु.चि.अधि.	चिकित्सीय कार्य	21,554.00	पो.ग्राम लुहारी	
19	श्री जी.पी.गुप्ता	आयु.चि.अधि.	चिकित्सीय कार्य	21,554.00	पो.ग्राम मझगुवां हंसराज	
20	श्री आर.के. गौतम	आयु.चि.अधि.	चिकित्सीय कार्य	23,309.00	पो.ग्राम भूरी	
21	श्री वी.पी. सोनी	आयु.चि.अधि.	चिकित्सीय कार्य	22,374.00	पो.ग्राम मढियादौ	
22	श्री एस.एल.जैन	आयु.चि.अधि.	चिकित्सीय कार्य	21,554.00	पो.ग्राम बिलाई	
23	श्री के.के.पटेरिया	आयु.चि.अधि.	चिकित्सीय कार्य	23,309.00	पो.ग्राम फतेहपुर	
24	श्री सीताराम मिश्रा	आयु.चि.अधि.	चिकित्सीय कार्य	10,426.00	पो.ग्राम सतपारा	
25	श्री एन.के.स्वर्णकार	आयु.चि.अधि.	चिकित्सीय कार्य	10,426.00	पो.ग्राम हिनौती	
26	श्री पी.एल.साहू	आयु.चि.अधि.	चिकित्सीय कार्य	10,504.00	चिकित्सालय दमोह	
27	श्री विनोद गुप्ता	आयु.चि.अधि.	चिकित्सीय कार्य	10,426.00	पो.ग्राम दिनारी	
28	श्री राजीव चौधरी	आयु.चि.अधि.	चिकित्सीय कार्य	29,391.00	चिकित्सालय दमोह	
29	श्री ए.के.वर्मा	आयु.चि.अधि.	चिकित्सीय कार्य	21,715.00	चिकित्सालय दमोह	
30	श्री बी.एम.गौतम	आयु.चि.अधि.	चिकित्सीय कार्य	10,426.00	पो.ग्राम रामगढ़	
31	श्री रम्मू रैकवार	कम्पाउन्डर	औषधि मिश्रक	7,524.00	नया बाजार नं.5, दमोह	

क्र०	नाम कर्मचारी	पद नाम	कर्तव्य	वेतन	पता	फोन नं.
32	डॉ.टी.आर. गौतम	सहा.चि.अधि.	चिकित्सीय कार्य	10,426.00	पो.ग्राम निबोरा	
33	डॉ. वाई.पी.गर्ग	सहा.चि.अधि.	चिकित्सीय कार्य	10,426.00	पो.ग्राम गैसाबाद	
34	श्री एस.पी. द्विवेदी	सहा.चि.अधि.	औषधि मिश्रक	10,825.00	पो.ग्राम बनगाव	
35	श्री हरिश्चन्द्र गुप्ता	सहा.चि.अधि.	चिकि.कार्य	10,426.00	पो.ग्राम हिनोता	
36	श्री वी.एम.गर्ग	कम्पाउन्डर	औषधि मिश्रक	9,424.00	पो.ग्राम बिलाई	
37	श्री के.बी. शुक्ला	कम्पाउन्डर	औषधि मिश्रक	9,624.00	पो.ग्राम बांदकपुर	
38	श्री शिवचरण अहिरवार	कम्पाउन्डर	औषधि मिश्रक	8,943.00	पो.ग्राम रजपुरा	
39	श्री जे.पी.खरे	कम्पाउन्डर	औषधि मिश्रक	10,426.00	पो.ग्राम लुहारी	
40	श्री महावीर यादव	कम्पाउन्डर	औषधि मिश्रक	7,920.00	पो.ग्राम खड्गेशी	
41	श्री आर.के.खरे	कम्पाउन्डर	औषधि मिश्रक	7,770.00	पो.ग्राम भूरी	
42	श्री गोपी बाई सेन	कम्पाउन्डर	औषधि मिश्रक	7,920.00	पो.ग्राम पिपरोधा	
43	श्री पराग जैन	कम्पाउन्डर	औषधि मिश्रक	6,868.00	पो.ग्राम सतपारा	
44	श्री उग्रसेन परते	कम्पाउन्डर	औषधि मिश्रक	6,115.00	पो.ग्राम छेवलादुबे	
45	श्री पुसू लाल	कम्पाउन्डर	औषधि मिश्रक	6,115.00	पो.ग्राम बनवार	
46	श्री भानू प्रसाद	कम्पाउन्डर	औषधि मिश्रक	6,115.00	पो.ग्राम किशुनगंज	
47	श्री हीरालाल	कम्पाउन्डर	औषधि मिश्रक	6,115.00	पो.ग्राम हिनोता	
48	श्री रामचरण मरावी	कम्पाउन्डर	औषधि मिश्रक	2,425.00	पो.ग्राम मनका	निलंबन
49	श्री गिरानी लाल	कम्पाउन्डर	औषधि मिश्रक	6,115.00	पो.ग्राम कुम्हारी	
50	श्री शिवकुमार बिदिया	कम्पाउन्डर	औषधि मिश्रक	6,115.00	पो.ग्राम चौपरा	
51	श्री राममिलन बिदुआ	कम्पाउन्डर	औषधि मिश्रक	7,920.00	पो.ग्राम फतेहपुर	
52	श्री बलवंत गौड	कम्पाउन्डर	औषधि मिश्रक	7,469.00	पो.ग्राम झलोन	
53	श्री एम.एल.शुक्ला	कम्पाउन्डर	औषधि मिश्रक	7,469.00	पो.ग्राम पटनामानगढ़	
54	श्रीमती ओ.पी.वर्मा	दाई	गर्भवती महिलाओं की देखरेख	9,153.00	पो.ग्राम छेवलादुबे	
55	श्रीमती सुशीला यादव	दाई	गर्भवती महिलाओं की देखरेख	8,351.00	पो.ग्राम अमाना	
56	श्रीमती राजकुमारी गौतम	दाई	गर्भवती महिलाओं की देखरेख	7,970.00	पो.ग्राम भूरी	
57	श्रीमती पार्वती गुप्ता	दाई	गर्भवती महिलाओं की देखरेख	7,900.00	पो.ग्राम तारादेही	
58	श्रीमती गीता बाई गर्ग	दाई	गर्भवती महिलाओं की देखरेख	7,820.00	पो.ग्राम बिलाई	
59	श्रीमती रेवती बाई गर्ग	दाई	गर्भवती महिलाओं की देखरेख	7,820.00	पो.ग्राम बालाकोट	
60	श्रीमती पार्वती शुक्ला	दाई	गर्भवती महिलाओं की देखरेख	7,820.00	पो.ग्राम बांदकपुर	
61	श्रीमती सीमा बाई गर्ग	दाई	गर्भवती महिलाओं की देखरेख	7,820.00	पो.ग्राम गैसाबाद	
62	श्रीमती हीरा बाई	दाई	गर्भवती महिलाओं की देखरेख	7,277.00	पो.ग्राम निबोरा	
63	श्रीमती राकेश कुमारी	दाई	गर्भवती महिलाओं की देखरेख	7,368.00	पो.ग्राम रामगढ़	

क्र०	नाम कर्मचारी	पद नाम	कर्तव्य	वेतन	पता	फोन नं.
64	श्रीमती हेमलता रैकवार	दाई	गर्भवती महिलाओं की देखरेख	7,368.00	पो.ग्राम झलौन	
65	श्रीमती कौशिल्या साहू	दाई	गर्भवती महिलाओं की देखरेख	7,820.00	पो.ग्राम मड़ियादौ	
66	श्रीमती ममता पांडे	दाई	गर्भवती महिलाओं की देखरेख	7,368.00	पो.ग्राम खडैरी	
67	श्रीमती ज्योति चौरहा	दाई	गर्भवती महिलाओं की देखरेख	7,368.00	पो.ग्राम पतलौनी	
68	श्रीमती कौशिल्या तिवारी	दाई	गर्भवती महिलाओं की देखरेख	7,277.00	पो.ग्राम सीतानगर	
69	श्रीमती अनीता पाठक	दाई	गर्भवती महिलाओं की देखरेख	7,277.00	पो.ग्राम बनवार	
70	श्रीमती सीमा तिवारी	दाई	गर्भवती महिलाओं की देखरेख	7,248.00	पो.ग्राम लुहारी	
71	श्रीमती सावित्री शुक्ला	दाई	गर्भवती महिलाओं की देखरेख	7,368.00	पो.ग्राम पटेरा	
72	श्रीमती सरोज गुरु	दाई	गर्भवती महिलाओं की देखरेख	2,000.00	दाई का निलंबन काल चल रहा	
73	श्री ठाकुर प्रसाद तिवारी	औष. सेवक	औषधियों का रखरखाव	6,738.00	पो.ग्राम बालाकोट	
74	श्री अजयकुमार श्रीवास्तव	औष. सेवक	औषधियों का रखरखाव	6,738.00	पो.ग्राम हिनोती	
75	श्री महेश चौकसे	औष. सेवक	औषधियों का रखरखाव	6,867.00	पो.ग्राम पटनामानगढ़	
76	श्री चन्द्रप्रकाश तिवारी	औष. सेवक	औषधियों का रखरखाव	6,738.00	पो.ग्राम सीतानगर	
77	श्रीमती श्यामाबाई	औष. सेवक	औषधियों का रखरखाव	6,998.00	पो.ग्राम बनवार	
78	श्रीमती पुष्पाबाई	औष. सेवक	औषधियों का रखरखाव	6,867.00	पो.ग्राम हिनोता	
79	श्री गणेश प्रसाद नेमा	औष. सेवक	औषधियों का रखरखाव	7,007.00	पो.ग्राम बांदकपुर	
80	श्री धर्मेन्द्र सिंह ठाकुर	औष. सेवक	औषधियों का रखरखाव	6,606.00	पो.ग्राम लुहारी	
81	श्री अरविंद प्रसाद	औष. सेवक	औषधियों का रखरखाव	6,606.00	पो.ग्राम बिलाई	
82	श्री भरत कुमार राय	औष. सेवक	औषधियों का रखरखाव	6,476.00	पो.ग्राम खडैरी	
83	श्री छोटे लाल रजक	औष. सेवक	औषधियों का रखरखाव	6,606.00	पो.ग्राम गैसाबाद	
84	श्री अमर सिंह ठाकुर	औष. सेवक	औषधियों का रखरखाव	6,606.00	पो.ग्राम सर्रा	
85	श्री गोपाल रैकवार	औष. सेवक	औषधियों का रखरखाव	5,965.00	पो.ग्राम मोहरई	
86	श्री फूलचंद रजक	औष. सेवक	औषधियों का रखरखाव	6,867.00	पो.ग्राम झलोन	
87	श्री राजेन्द्र कुमार चढ़ार	औष. सेवक	औषधियों का रखरखाव	6,867.00	पो.ग्राम मझगुवां	
88	श्री हरिचरण गुरु	औष. सेवक	औषधियों का रखरखाव	6,738.00	पो.ग्राम दिनारी	
89	श्री राजेश कुमार	औष. सेवक	औषधियों का रखरखाव	6,606.00	पो.ग्राम निबोराकलां	
90	श्रीमती शकुंतला वर्मन	औष. सेवक	औषधियों का रखरखाव	6,446.00	पो.ग्राम फतेहपुर	
91	श्री बालचंद साहू	औष. सेवक	औषधियों का रखरखाव	5,965.00	पो.ग्राम भूरी	
92	श्री कमलापति बनगांव	औष. सेवक	औषधियों का रखरखाव	5,965.00	पो.ग्राम बनगांव	
93	श्री डी.पी.तिवारी	औष. सेवक	औषधियों का रखरखाव	6,446.00	पो.ग्राम पतलोनी	
94	श्री मुन्ना लाल रैकवार	औष. सेवक	औषधियों का रखरखाव	6,325.00	पो.ग्राम किशुनगंज	

क्र०	नाम कर्मचारी	पद नाम	कर्तव्य	वेतन	पता	फोन नं.
95	श्री धनीराम पटैल	औष. सेवक	औषधियों का रखरखाव	7,369.00	पो.ग्राम सदगुवा	
96	श्री पुष्पेन्द्र शर्मा	कम्पाउन्डर होम्यो	औषधि मिश्रक	6,567.00	पो.ग्राम पटेरा	
97	डॉ.ओ.पी.तिवारी	सहा.हो.चि.अधि.	चिकित्सकीय कार्य	16,040.00	पो.ग्राम पटेरा	
98	श्री चतुर्भुज	संविदा कम्पाउन्डर	औषधि मिश्रक	2,200.00	पो.ग्राम बम्होरी माला	
99	श्री लक्ष्मीप्रसाद कोरी	संविदा कम्पाउन्डर	औषधि मिश्रक	2,200.00	पो.ग्राम हिनोती	
100	श्रीमती सुनीता अहिरवार	संविदा कम्पाउन्डर	औषधि मिश्रक	2,200.00	पो.ग्राम पतलोनी	
101	श्री भानकुंवर अहिरवार	संविदा दाई	गर्भवती महिलाओं की देखरेख	2,200.00	पो.ग्राम किशुनगंज	
102	श्रीमती पार्वती चढ़ार	औषधालय सेवक	औषधियों का रखरखाव	5,143.00	पो.ग्राम हो.औ.पटेरा	
103	श्रीमती लक्ष्मीबाई अहिरवार	संविदा दाई	गर्भवती महिलाओं की देखरेख	2,200.00	ग्राम पोस्ट बम्होरीमाला	
104	श्रीमती अंजनी राय	संविदा दाई	गर्भवती महिलाओं की देखरेख	2,200.00	ग्राम पोस्ट बनगांव	
105	श्रीमती कुंवर देवी	संविदा दाई	गर्भवती महिलाओं की देखरेख	2,200.00	ग्राम पोस्ट हिनोता	
106	श्रीमती अनीता मुण्डा	संविदा दाई	गर्भवती महिलाओं की देखरेख	2,200.00	ग्राम पोस्ट कुम्हारी	
107	श्रीमती संतोषी अद्या	संविदा दाई	गर्भवती महिलाओं की देखरेख	2,200.00	ग्राम पोस्ट सतपारा	
108	श्रीमती गायत्री अहिरवार	संविदा दाई	गर्भवती महिलाओं की देखरेख	2,200.00	ग्राम पोस्ट चौपरा	
109	श्री आनंद मुण्डा	संविदा औष.सेवक	गर्भवती महिलाओं की देखरेख	1,800.00	ग्राम पोस्ट तारादेही	
110	श्री अनरत सींग	संविदा औष.सेवक	गर्भवती महिलाओं की देखरेख	1,800.00	ग्राम पोस्ट सतपारा	
111	श्री ललित चौधरी	संविदा औष.सेवक	गर्भवती महिलाओं की देखरेख	1,800.00	ग्राम पोस्ट अभाना	
112	श्रीमती दमयंती मुण्डा	संविदा औष.सेवक	गर्भवती महिलाओं की देखरेख	1,800.00	ग्राम पोस्ट कुम्हारी	
113	कृ.दमयंती मुण्डा	संविदा औष.सेवक	गर्भवती महिलाओं की देखरेख	1,800.00	ग्राम पोस्ट रामगढ़	

कार्यालय अधीक्षक सह जिला आयुर्वेद अधिकारी, दमोह
अधीन : आयुर्वेद/होम्यो औषधालयों में कार्यरत स्टाॅफ

क्र०	नाम कर्मचारी	पद नाम	कर्तव्य	वेतन	पता	फोन नं.
1	2	3	4	5	6	7
1	श्री विनोद कुमार	स्वच्छक	सफाई	2,602.00	दमोह	
2	श्री रमा यादव	किचिन सर्वेन्ट	कुकिंग	2,602.00	दमोह	
3	श्री सरस्वती बाई	स्वच्छक	सफाई	2,602.00	दमोह	
4	श्री बृजेन्द्र रैकवार	वार्ड व्याय	मरीजों की सेवा	2,602.00	दमोह	
5	श्री विनोद पाण्डेय	वार्ड व्याय	मरीजों की सेवा	2,602.00	दमोह	
6	श्री रामसेवक	वासरमेन	कपड़ों की धुलाई	2,602.00	दमोह	
7	श्री कोदूलाल	अंशकालीन स्वच्छक	सफाई	1,301.00	बालाकोट	
8	श्री वृन्दावन	अंशकालीन स्वच्छक	सफाई	1,301.00	किशनुगंज	
9	श्री नन्हे भाई	अंशकालीन स्वच्छक	सफाई	1,301.00	सतपारा	
10	श्री बाबू लाल	अंशकालीन स्वच्छक	सफाई	1,301.00	मनका	
11	श्री प्रेमदास	अंशकालीन स्वच्छक	सफाई	1,301.00	रामगढ़	
12	श्री सुदामा	अंशकालीन स्वच्छक	सफाई	1,301.00	दिनारी	
13	श्री गुरुदयाल	अंशकालीन स्वच्छक	सफाई	1,301.00	फतेहपुर	
14	श्री महेश सेन	अंशकालीन स्वच्छक	सफाई	1,301.00	रजपुरा	
15	श्री सूरज	अंशकालीन स्वच्छक	सफाई	1,301.00	मोहरई	
16	श्री किस्सू	अंशकालीन स्वच्छक	सफाई	1,301.00	मड़ियादो	
17	श्री छुन्नी लाल	अंशकालीन स्वच्छक	सफाई	1,301.00	गैसाबाद	
18	श्री सुखलाल	अंशकालीन स्वच्छक	सफाई	1,301.00	बनगांव	
19	श्री छेकोड़ी	अंशकालीन स्वच्छक	सफाई	1,301.00	लुहारी	
20	श्री रमेश	अंशकालीन स्वच्छक	सफाई	1,301.00	अभाना	
21	श्री हल्लू	अंशकालीन स्वच्छक	सफाई	1,301.00	पटना मानगढ़	
22	श्री पुतुलाल	अंशकालीन स्वच्छक	सफाई	1,301.00	बम्होरी माला	
23	श्री पूना बाई	अंशकालीन स्वच्छक	सफाई	1,301.00	चौपरा	
24	श्री सब्बू लाल	अंशकालीन स्वच्छक	सफाई	1,301.00	बनवार	
25	श्री शिशु कुमार	अंशकालीन स्वच्छक	सफाई	1,301.00	नोहटा	
26	श्री मन्नू लाल	अंशकालीन स्वच्छक	सफाई	1,301.00	तारादेही	
27	श्री राजू	अंशकालीन स्वच्छक	सफाई	1,301.00	बांदकपुर	
28	श्री इमरत	अंशकालीन स्वच्छक	सफाई	1,301.00	बिलाई	
29	श्री रघुवीर	अंशकालीन स्वच्छक	सफाई	1,301.00	निवोराकलां	
30	श्री नारायण	अंशकालीन स्वच्छक	सफाई	1,301.00	खड़ेरी	
31	श्री गंगू	अंशकालीन स्वच्छक	सफाई	1,301.00	छेवलादुबे	
32	श्री मूलचंद	अंशकालीन स्वच्छक	सफाई	1,301.00	मझगुवाहंसराज	
33	श्री जीवन	अंशकालीन स्वच्छक	सफाई	1,301.00	कुम्हारी	
34	श्री हरिचरण	अंशकालीन स्वच्छक	सफाई	1,301.00	झलौन	
35	श्री नोनेलाल	अंशकालीन स्वच्छक	सफाई	1,301.00	हिनौती	
36	श्री नन्हे भाई	अंशकालीन स्वच्छक	सफाई	1,301.00	सर्रा	
37	श्री मन्नू लाल	अंशकालीन स्वच्छक	सफाई	1,301.00	पतलोनी	

कार्यालय में अपनाई जाने वाली निर्णय प्रक्रिया

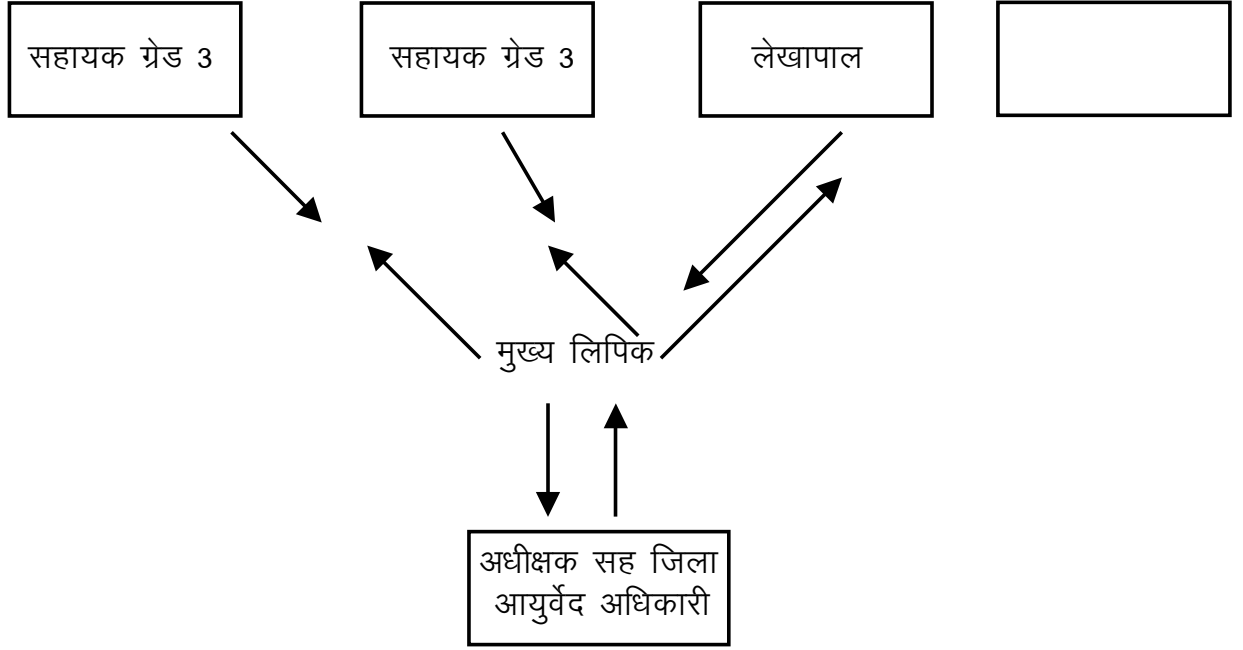

कार्यालय अधीक्षक सह जिला आयुर्वेद अधिकारी, दमोह

क्र०	कार्य गतिविधि योजना का नाम	प्रभारी अधिकारी	निपटारे की समय सीमा
1	2	3	4
1	सेवा निवृत्ति / मृत्यु पर अवकाश नगदीकरण की स्वीकृति	कार्यालय प्रमुख	एक माह
2	उपदान एवं पेंशन	कार्यालय प्रमुख	एक माह
3	परिवार कल्याण निधि का भुगतान	कार्यालय प्रमुख	तीन माह
4	सामान्य भविष्य निधि का भुगतान	कार्यालय प्रमुख	तीन माह
5	परिवार अनुग्रह राशि एक्सग्रोसिया	कार्यालय प्रमुख	तीन दिन
6	अन्य भुगतान	कार्यालय प्रमुख	एक माह
1	सूचना के अधिकार के अंतर्गत प्राप्त आवेदन पत्रों में नकल प्रदाय	जिला संस्था प्रमुख	15 दिवस
2	सूचना के अधिकार के अंतर्गत अभिलेखों के अवलोकन की सूचना देना	जिला संस्था प्रमुख	15 दिवस
3	सूचना के अधिकार के अंतर्गत अभिलेखों के अवलोकन की सूचना देना	जिला संस्था प्रमुख	15 दिवस

सिटीजन चार्टर के तहत वर्णित विभिन्न प्रकार के आवेदनों को यदि विहित अधिकारी/प्रभारी अधिकारी द्वारा समय पर निराकरण नहीं किया जाता है और न ही अपीलकर्ता की अपील पर संबंधित अधिकारी द्वारा समय सीमा में कार्यवाही नहीं की जाती है तब ऐसी स्थिति में आम नागरिक राज्य शासन को ईमेल पर अथवा सीधे आवेदन कर सकते हैं ।

कार्यालय अधीक्षक सह जिला आयुर्वेद अधिकारी, दमोह

S.No .	Name of Document	Kind of Document like microfilm Register Book Diskettor etc.	Nature and Content of Document	Duration of Records
1	2	3	4	5
1	स्थापना		सेवा पुस्तिका गोपनीय चरित्रावली विधानसभा शासन निर्देश शिकायत	
2	लेखा		बिल पंजी बी.टी.वीं अग्रिम पंजी G.P.G., T.A. Ad. Pay , Ad. D.P.F. , F, Ad, , G.Ad. Mopaid	
3	स्टोर		औषधि स्टॉक पंजी बिल T.A. M.R. , C.C., & Pay क्रय आदेश निर्देश औषधालय बिल वितरण पंजी	

कार्यालय अधीक्षक सह जिला आयुर्वेद अधिकारी, दमोह

461 आयुर्वेद प्र शासन एवं सुदृढीकरण

मद	भीर्श	बजट	12/07 तक खर्च	अव शेष राशि	
वेतन 11	001	500000	380950	119050	
मंहगाई भत्ता	003	150000	138501	11499	
मकान किराया भत्ता	006	13000	78959	5041	
अन्य भत्ते	008	2000	540	1460	
चिकित्सा प्रतिपूर्ति	009	5000		5000	
त्यौहार अग्रिम	0011	1000		1000	
अनाज अग्रिम	016	2000	2000		
मंहगाई वेतन	027	250000	164516	85484	
योग	920000	692466	227534	
मजदूरी	12	15000	17962	15038	
यात्रा व्यय 21	001	5000	3316	1684	
कार्यालय व्यय 22	डाक एवं तार सेवा व्यय	001	2000	2000	
	बिजली एवं जल	005	8000	1905	6095
	बर्दिया	006	1000	928	72
	लेखन सामग्री	007	5000	4885	115
	भवन किराया	011	28000	21600	6400
सामग्री प्रदाय 34	009	2000		2000	
अन्य खर्च	51	4000	4000		
अन्य योग		70000	56596	13404	
महायोग		990000	749062	240938	

कार्यालय अधीक्षक सह जिला आयुर्वेद अधिकारी, दमोह

461 आयुर्वेद प्रशासन एवं सुदृढीकरण

मद	भीर्श	बजट	12/07 तक खर्च	अवशेष राशि
वेतन 11	001	8400000	5539456	2860546
मंहगाई भत्ता	003	2520000	2006825	511375
मकान किराया भत्ता	006	220000	136951	83049
अन्य भत्ते	008	22000	14110	7890
चिकित्सा प्रतिपूर्ति	009	45000 + 100000	122531	22469
त्यौहार अग्रिम	0011	5000		5000
अनाज अग्रिम	016	10000	6000	4000
मंहगाई वेतन	027	4200000	2358609	1841391
योग	15407000 + 100000	10178480	5328520
मजदूरी	12	650000	512354	137646
यात्रा व्यय 21	001	80000 + 300000	379812	188
कार्यालय व्यय 22	डाक एवं तार सेवा व्यय	001	3000	3000
	बिजली एवं जल	005	30000	18744
	बर्दिया	006	12000	11298
	लेखन सामग्री	007	12000	1179
	भवन किराया	011	75000	48161
सामग्री प्रदाय 34	009	35000	9681	25319
अन्य योग		897000 + 300000	994843	202157
महायोग		16304000 + 400000	11173323	5530677

नोट— अनाज अग्रिम का 6000/- रूपया महायोग में शामिल नहीं है।

कार्यालय अधीक्षक सह जिला आयुर्वेद अधिकारी, दमोह

461 आयुर्वेद प्र ासन एवं सुदृढीकरण

मद	भीर्श	बजट	12/07 तक खर्च	अव ेश रािा
वेतन 11	001	280000	194240	85760
मंहगाई भत्ता	003	84000	73444	10556
मकान किराया भत्ता	006	7000	4328	2672
अन्य भत्ते	008	4000	990	3010
चिकित्सा प्रतिपूर्ति	009	2000	1974	26
त्यौहार अग्रिम	0011	1000		1000
अनाज अग्रिम	016	1000		1000
मंहगाई वेतन	027	14000	85265	54735
योग	517000	360241	156759
मजदूरी	12	20000	10345	9655
यात्रा व्यय 21	001	2000	1988	12
कार्यालय	बिजली एवं जल	005	1000	1000
व्यय 22	बर्दिया	006	1000	889
	भवन किराया	011	3000	800
सामग्री प्रदाय 34	009	1000		1000
अन्य योग		28000	14022	13978
महायोग		54500	374263	170737

कार्यालय अधीक्षक सह जिला आयुर्वेद अधिकारी दमोह

लोक सूचना अधिकारी से संबंधित जानकारी

क्र.	नाम	पद	फोन नंबर	कार्यालय का पता	निवास पता
1	डॉ.पी.पी.शर्मा	अधीक्षक सह जिला आयुर्वेद	228791 कार्यालय 224377 निवास	कार्या. अधी.सह जिला आयु. अधि. दमोह	रेस्ट हाउस के पीछे एफ.9 ऑफीसर कालोनी ,दमोह
सहायक लोक सूचना अधिकारी					
2	डॉ.आर.के.मिश्रा	आयुर्वेद चिकित्सा अधिकारी	228791 कार्यालय 221110 निवास	शास.आयु.औष.बालाकोट	गार्ड लाइन,दमोह

बिन्दु क्रमांक 5, 7, 8, 12, 13, 14, 15, 17

कार्यालय अधीक्षक सह जिला आयुर्वेद अधिकारी दमोह

बिन्दु क्रमांक 5 / 7 / 8 / 12 / 13 / 14 / 15 / 17

उपरोक्त बिन्दुओं की जानकारी निरंक हैं।